

RevNo	Revision note	Date	Signature	Checked

1	63AMP 6KA SINGLE PHASE CIRCUIT BREAKER FOR TENANT MAINS
2	100AMP SERVICE FUSE HOLDERS
3	SINGLE PHASE ELECTRIC METERS BY OTHERS
4	NEUTRAL LINK
5	POLE FILLER

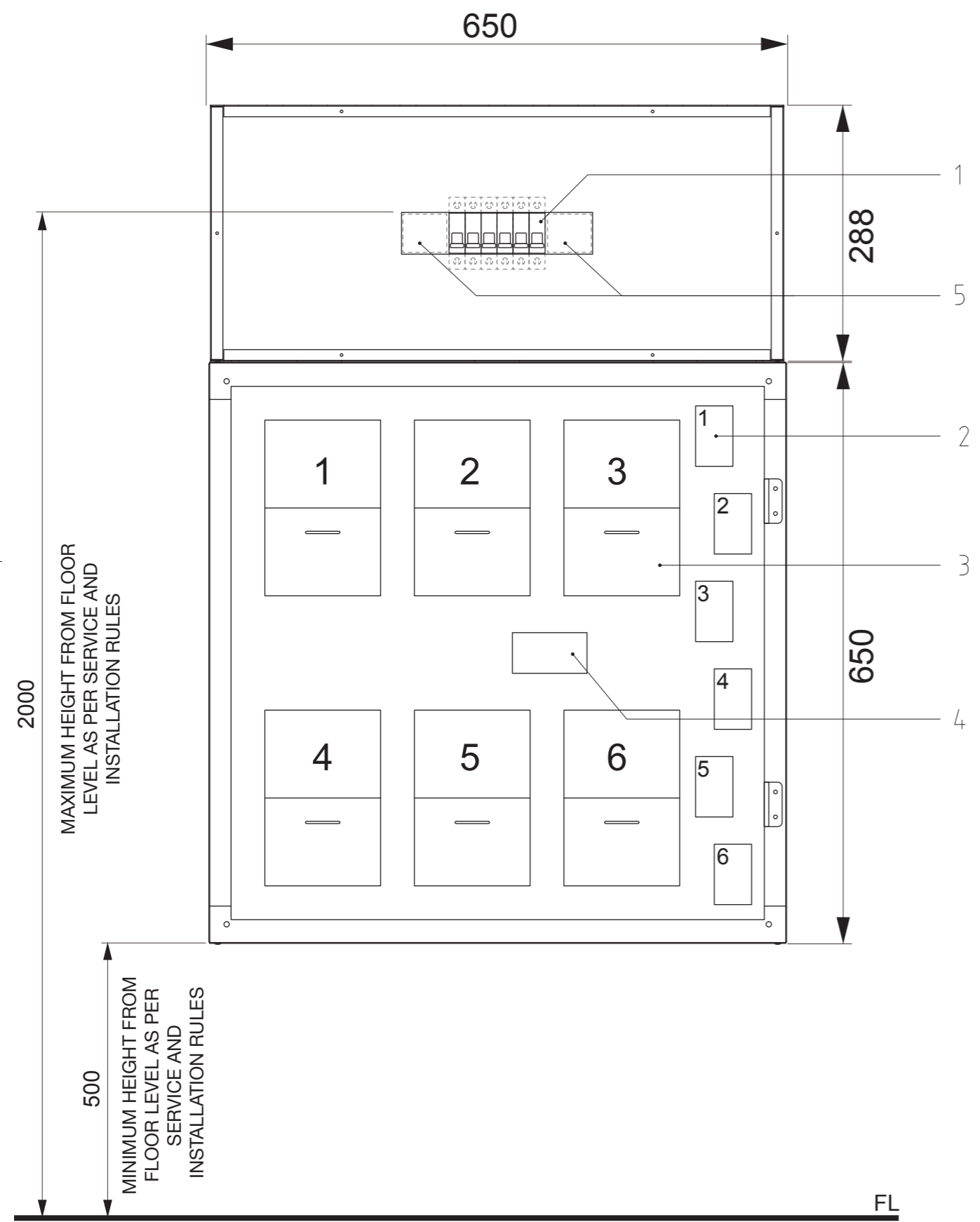
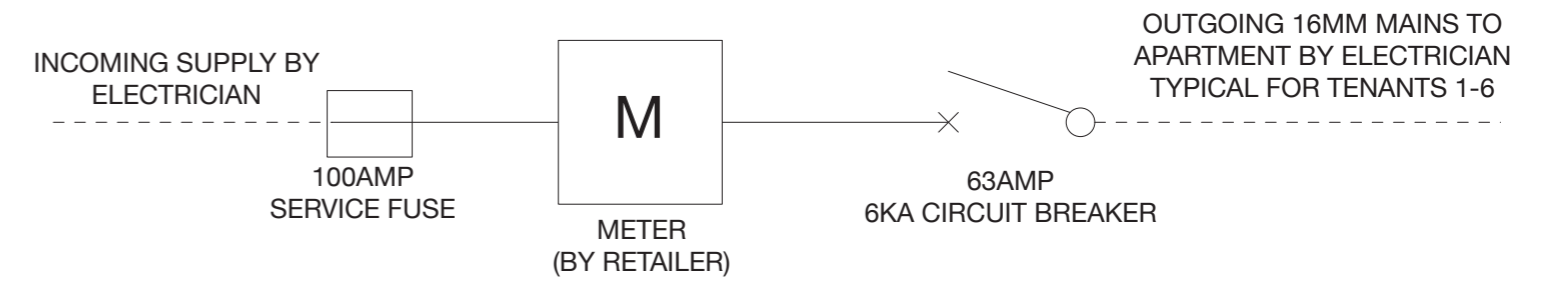

SHEET	1	SCALE	NTS	FILE NAME
SIZE	A3	0-6 WAY METER PANEL		
DRAWN	DV	POWERLIGHT PTY LTD		
CHECK	SV	19 ALEX AVE, MOORABBIN, VIC 3189		
APPR.		PH: (03) 9555 9966		
ISSUED		FAX: (03) 9555 9699		
REV				
CONTRACT NO				

RevNo	Revision note	Date	Signature	Checked

1	63AMP 6KA SINGLE PHASE CIRCUIT BREAKER FOR TENANT MAINS
2	100AMP SERVICE FUSE HOLDERS
3	SINGLE PHASE ELECTRIC METERS BY OTHERS
4	NEUTRAL LINK
5	POLE FILLER

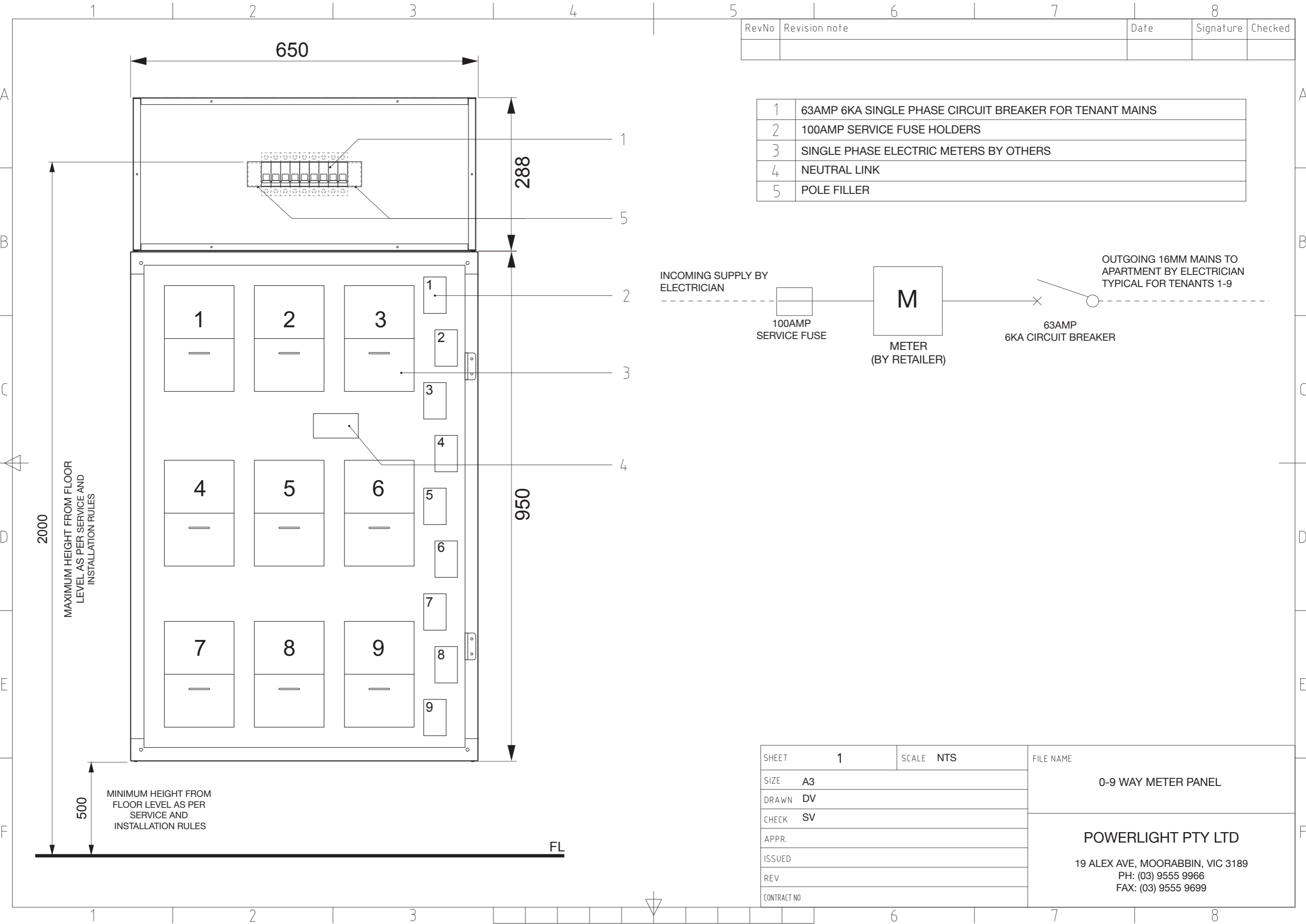
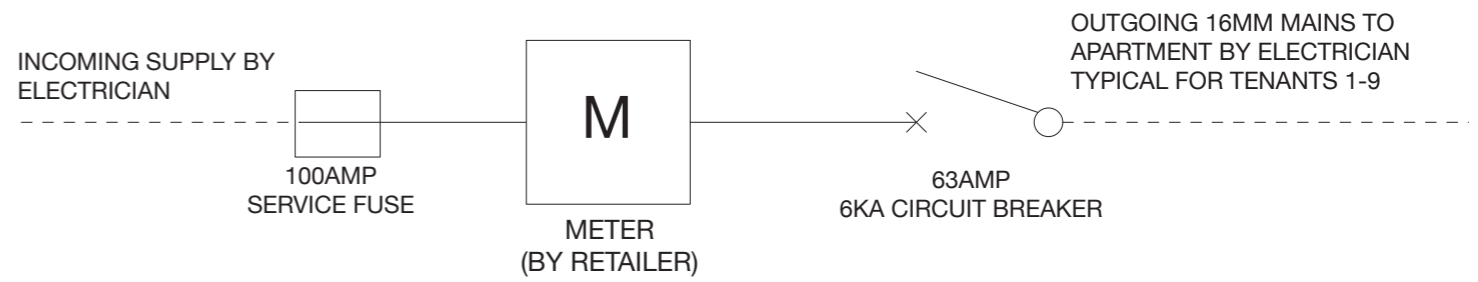

SHEET	1	SCALE	NTS	FILE NAME
SIZE	A3	0-9 WAY METER PANEL		
DRAWN	DV	POWERLIGHT PTY LTD		
CHECK	SV	19 ALEX AVE, MOORABBIN, VIC 3189		
APPR.		PH: (03) 9555 9966		
ISSUED		FAX: (03) 9555 9699		
REV				
CONTRACT NO				

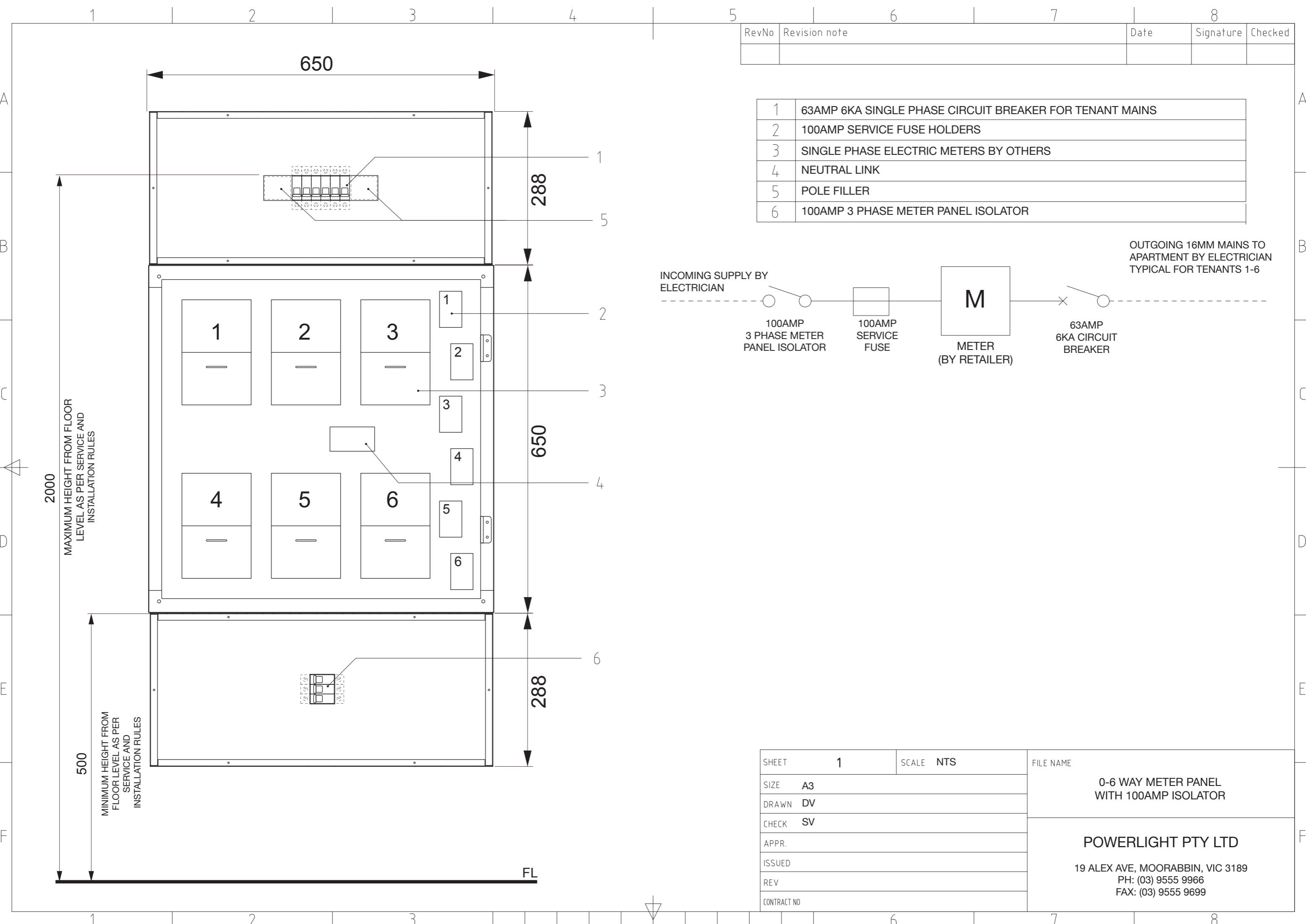

RevNo	Revision note	Date	Signature	Checked

1	63AMP 6KA SINGLE PHASE CIRCUIT BREAKER FOR TENANT MAINS
2	100AMP SERVICE FUSE HOLDERS
3	SINGLE PHASE ELECTRIC METERS BY OTHERS
4	NEUTRAL LINK
5	POLE FILLER
6	100AMP 3 PHASE METER PANEL ISOLATOR

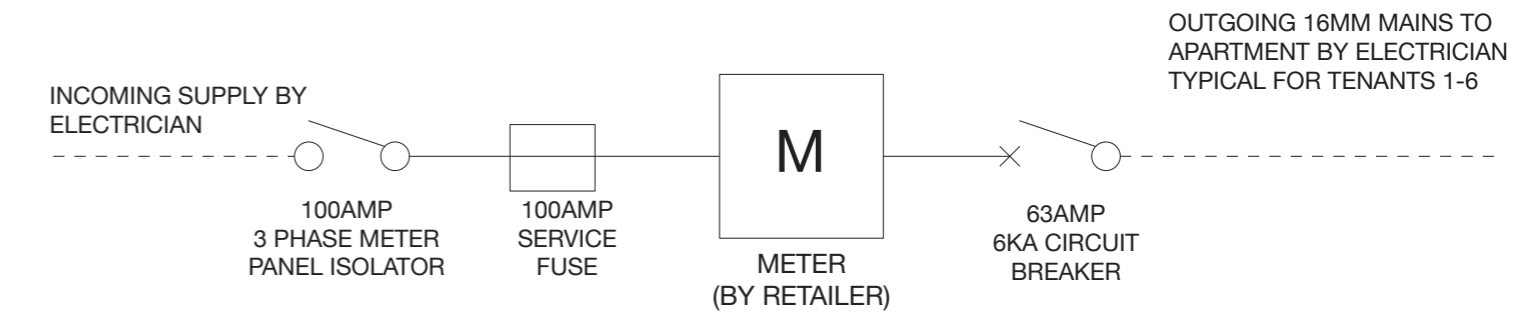

SHEET	1	SCALE	NTS	FILE NAME
SIZE	A3	0-6 WAY METER PANEL WITH 100AMP ISOLATOR		
DRAWN	DV			
CHECK	SV	POWERLIGHT PTY LTD 19 ALEX AVE, MOORABBIN, VIC 3189 PH: (03) 9555 9966 FAX: (03) 9555 9699		
APPR.				
ISSUED				
REV				
CONTRACT NO				

RevNo	Revision note	Date	Signature	Checked

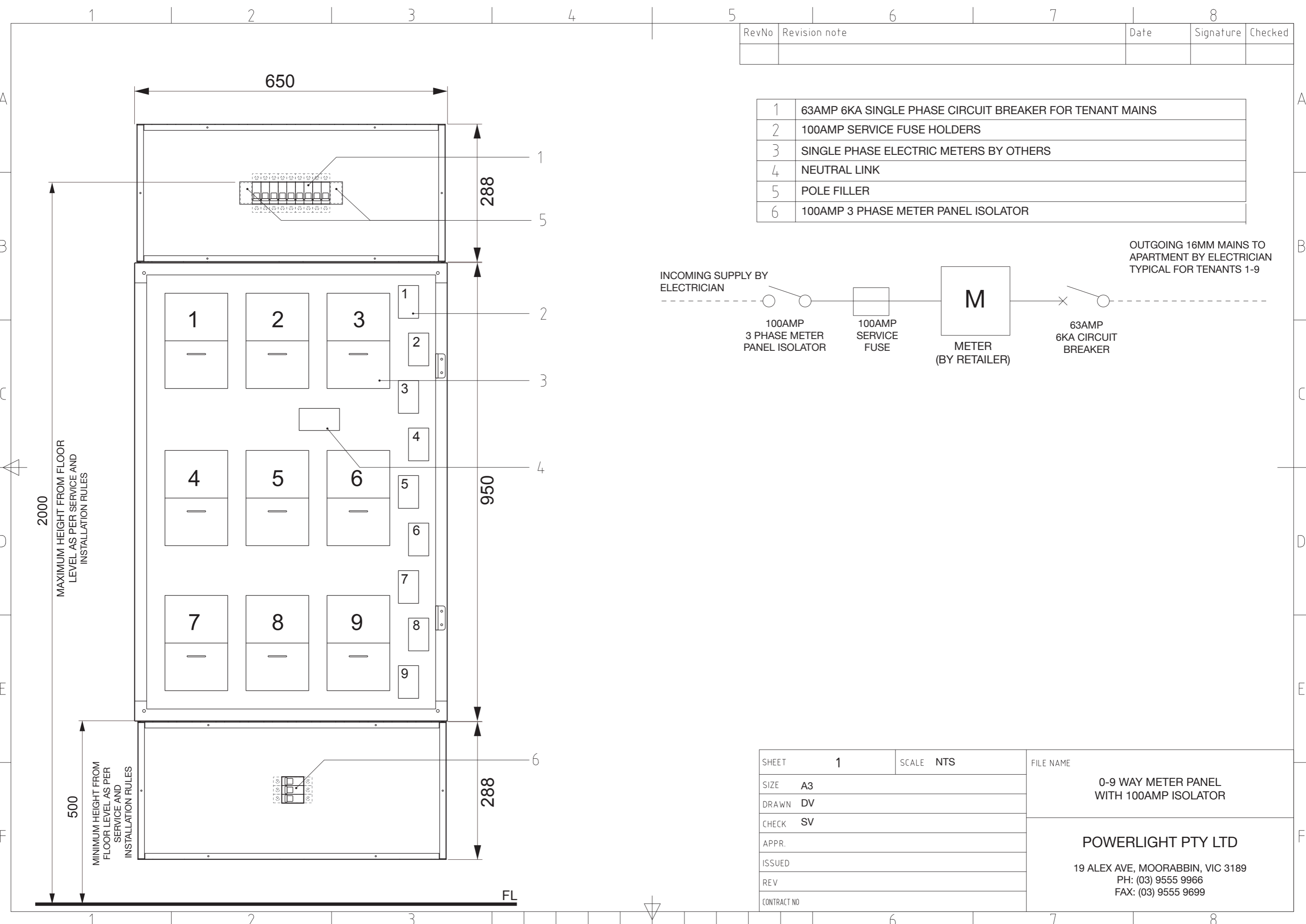

1	63AMP 6KA SINGLE PHASE CIRCUIT BREAKER FOR TENANT MAINS
2	100AMP SERVICE FUSE HOLDERS
3	SINGLE PHASE ELECTRIC METERS BY OTHERS
4	NEUTRAL LINK
5	POLE FILLER
6	100AMP 3 PHASE METER PANEL ISOLATOR

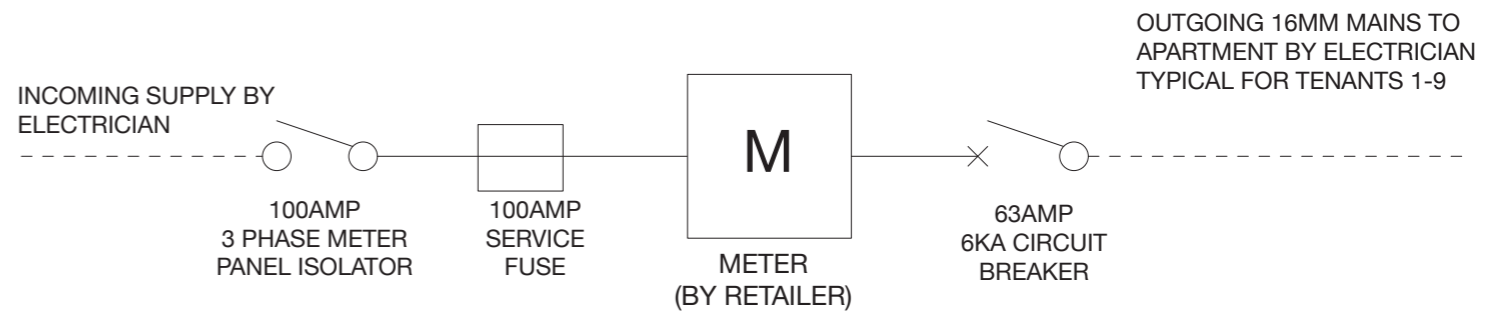

SHEET	1	SCALE	NTS	FILE NAME
SIZE	A3	0-9 WAY METER PANEL WITH 100AMP ISOLATOR		
DRAWN	DV			
CHECK	SV	POWERLIGHT PTY LTD 19 ALEX AVE, MOORABBIN, VIC 3189 PH: (03) 9555 9966 FAX: (03) 9555 9699		
APPR.				
ISSUED				
REV				
CONTRACT NO				

RevNo	Revision note	Date	Signature	Checked

1	63AMP 6KA SINGLE PHASE CIRCUIT BREAKER FOR TENANT MAINS
2	100AMP SERVICE FUSE HOLDERS
3	SINGLE PHASE ELECTRIC METERS BY OTHERS
4	NEUTRAL LINK
5	250AMP 3 PHASE METER PANEL MAIN SWITCH
6	100AMP 3 PHASE CIRCUIT BREAKER FOR PANEL A
7	100AMP 3 PHASE CIRCUIT BREAKER FOR PANEL B

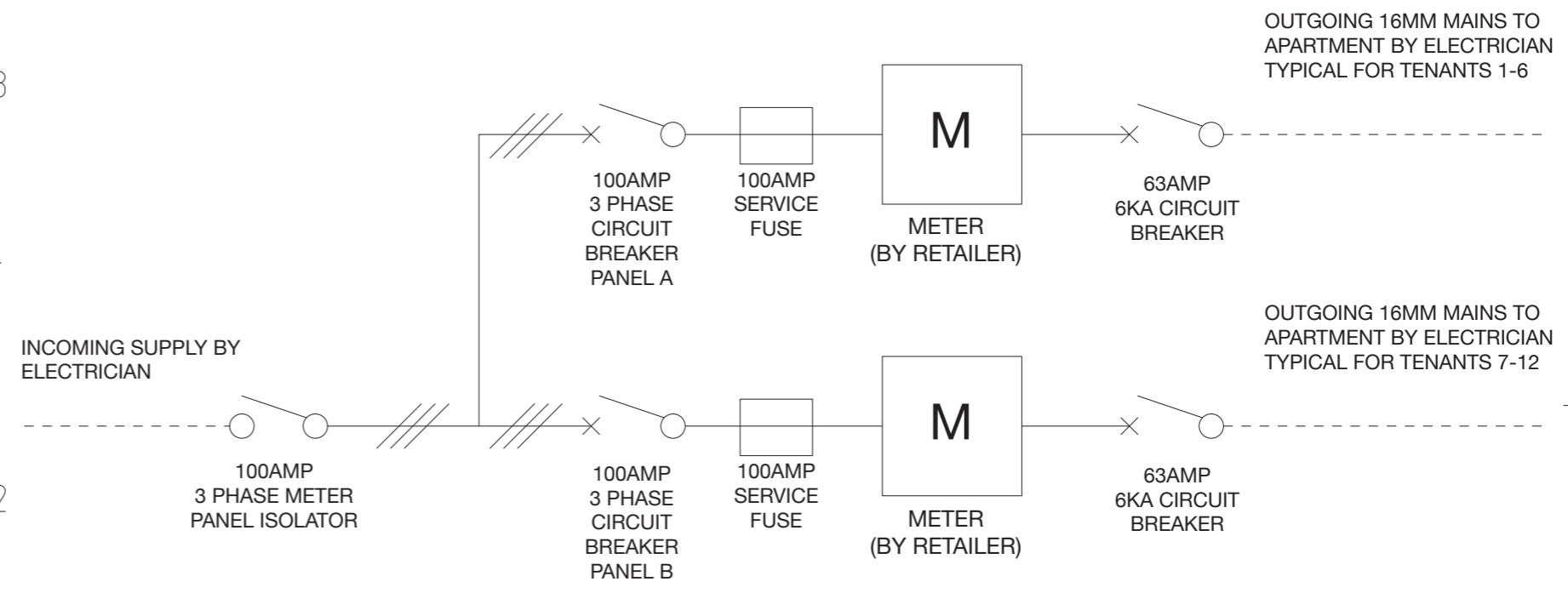

SHEET	1	SCALE	NTS	FILE NAME	0-12 WAY METER PANEL
SIZE	A3				
DRAWN	DV				
CHECK	SV				
APPR.					
ISSUED					
REV					
CONTRACT NO					
				POWERLIGHT PTY LTD 19 ALEX AVE, MOORABBIN, VIC 3189 PH: (03) 9555 9966 FAX: (03) 9555 9699	